

RX-78NT1 GUNDAM NT-1 #1

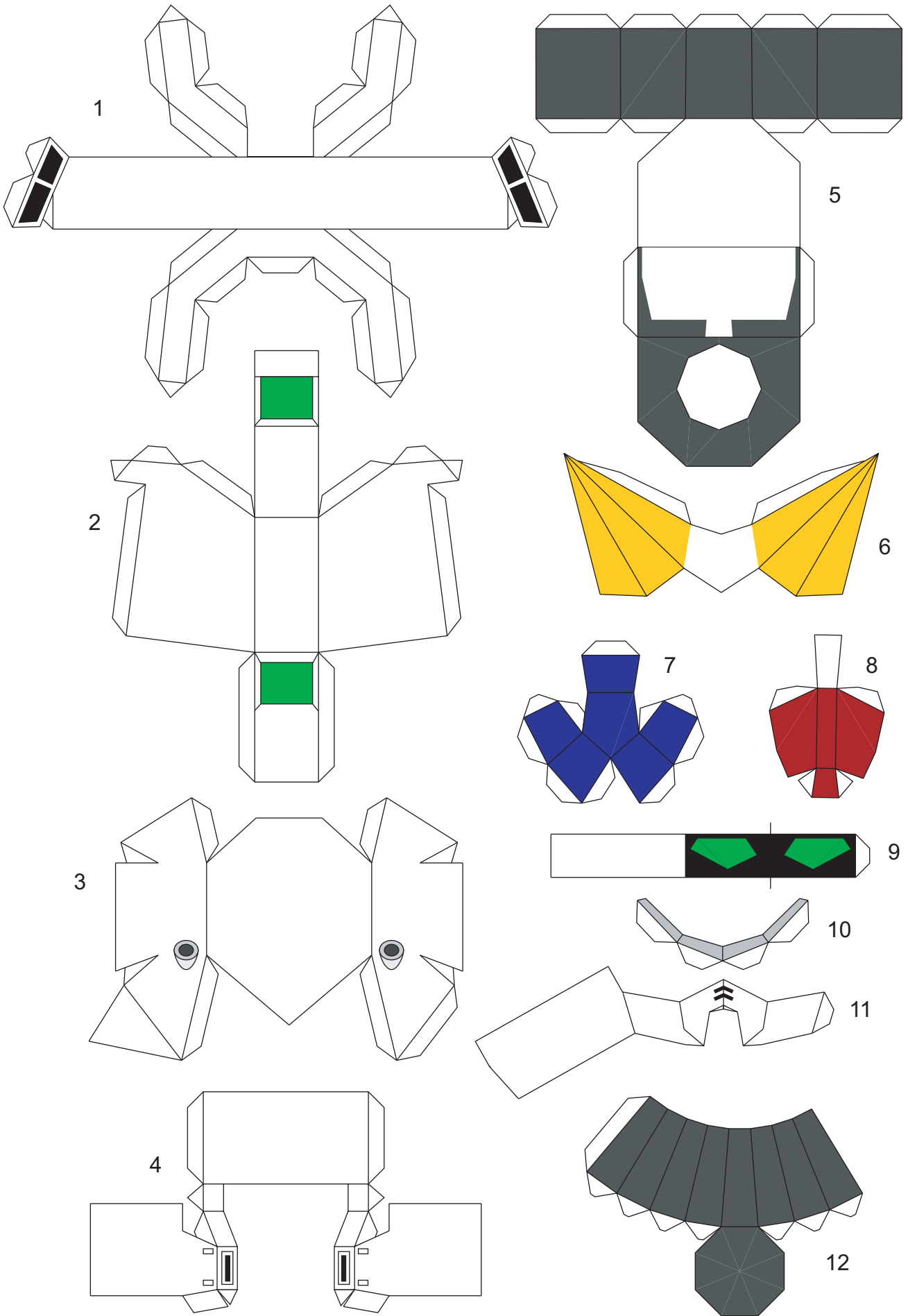

RX-78NT1 GUNDAM NT-1 #2

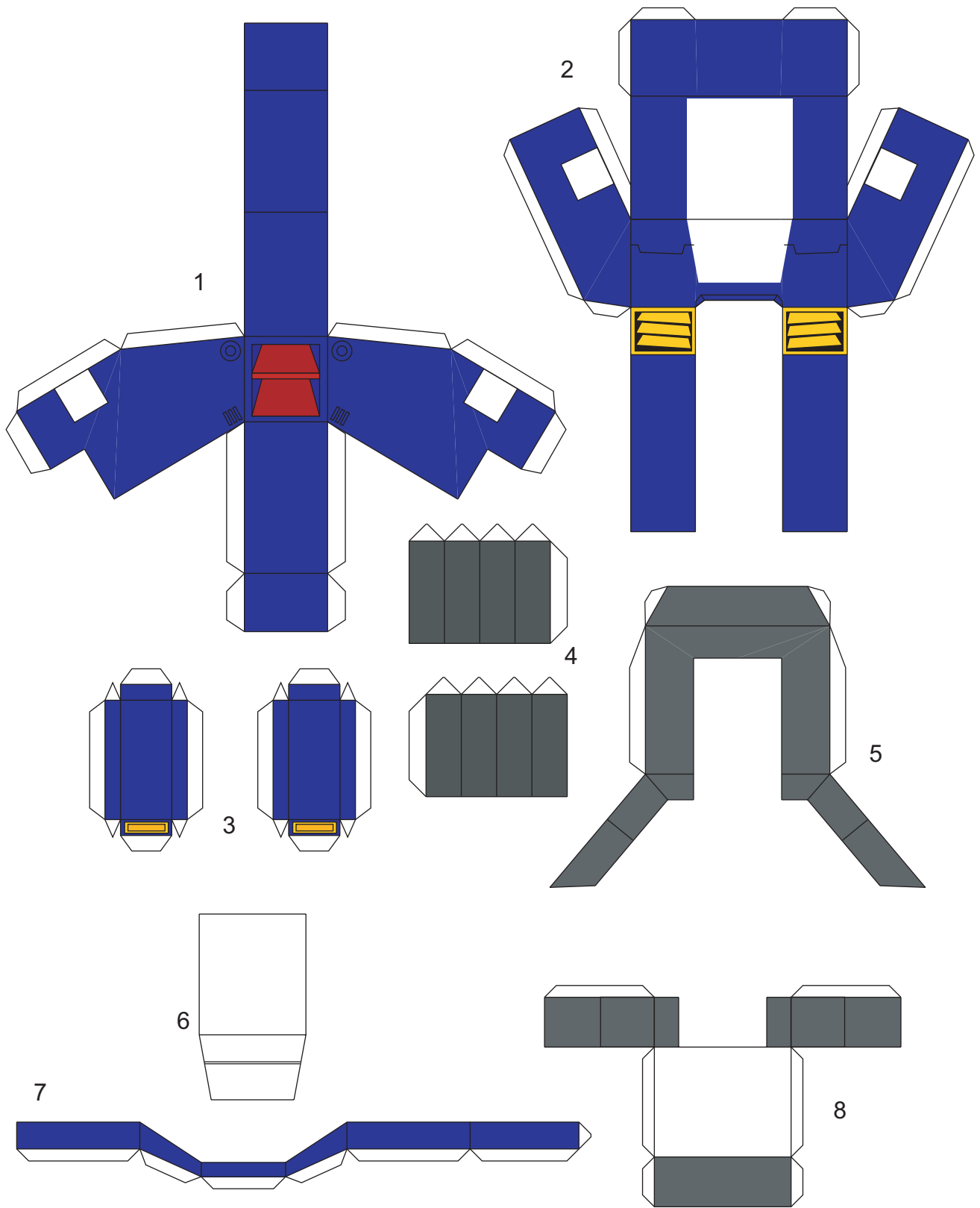

RX-78NT1 GUNDAM NT-1 #3

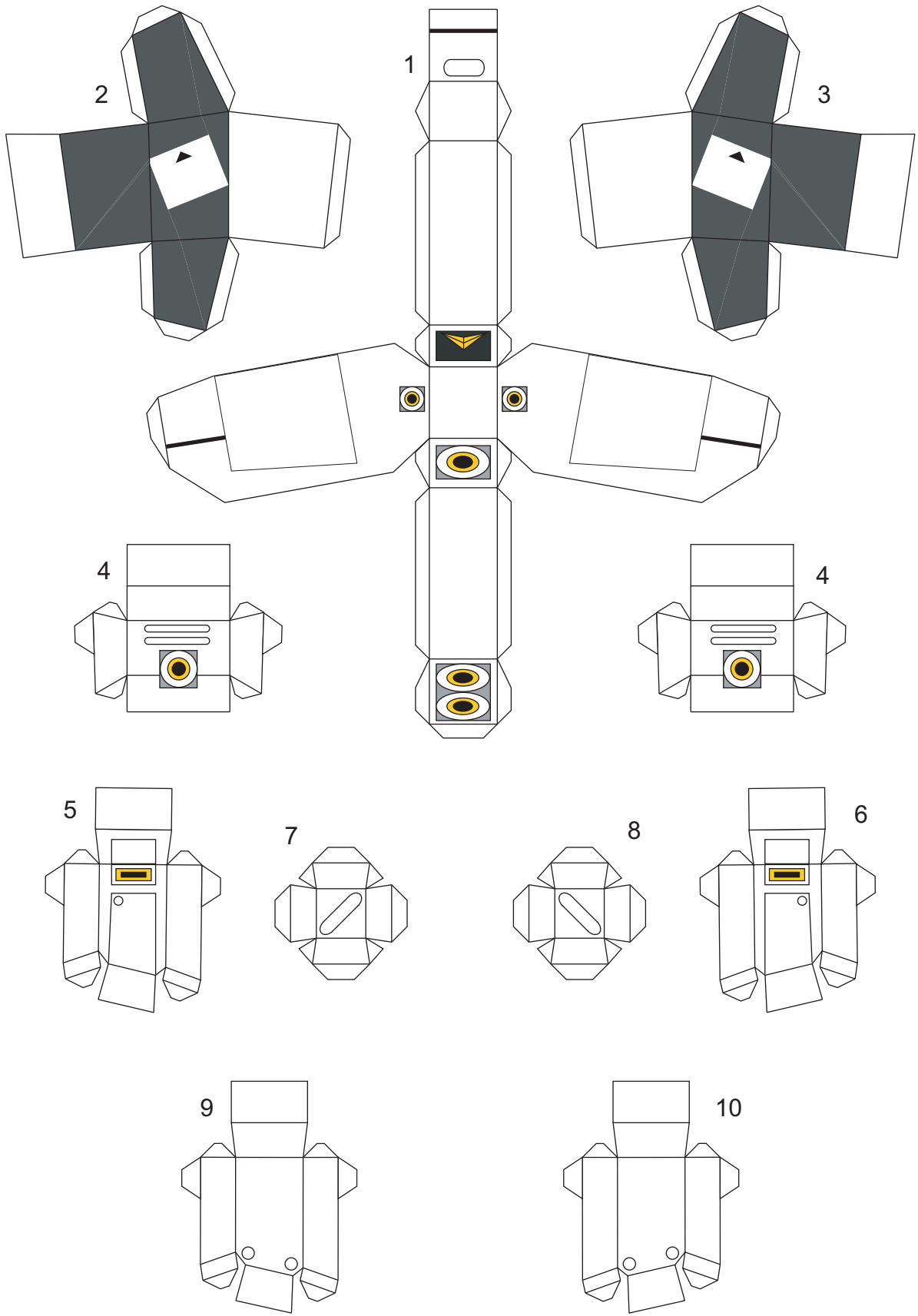

RX-78NT1 GUNDAM NT-1 #4

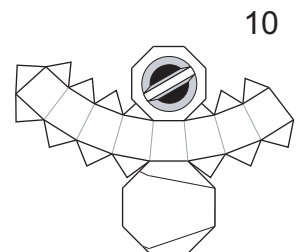
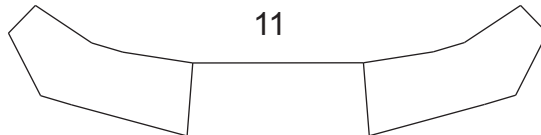
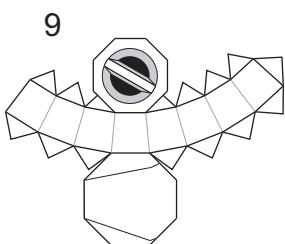
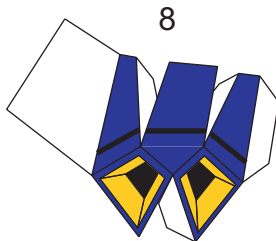
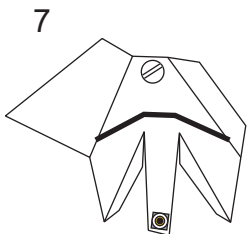
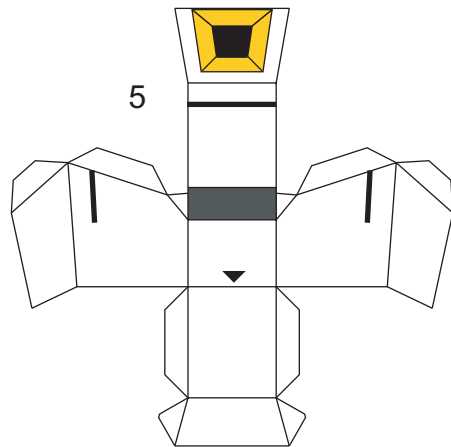
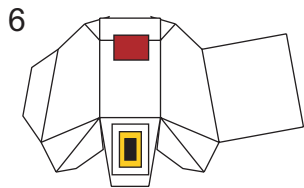
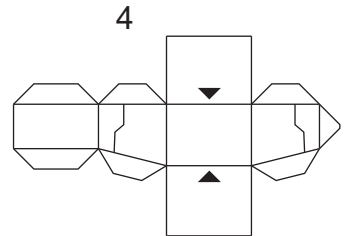
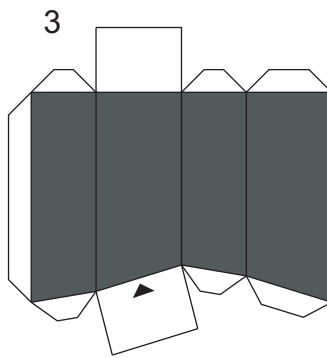
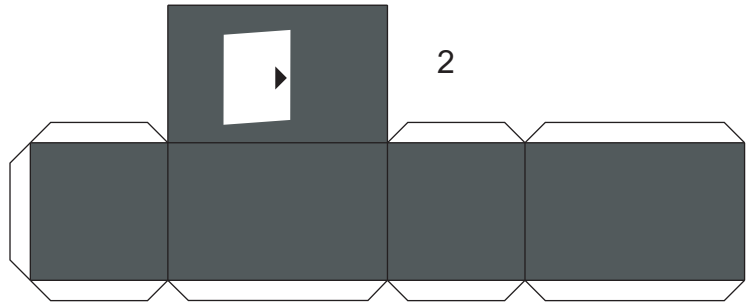
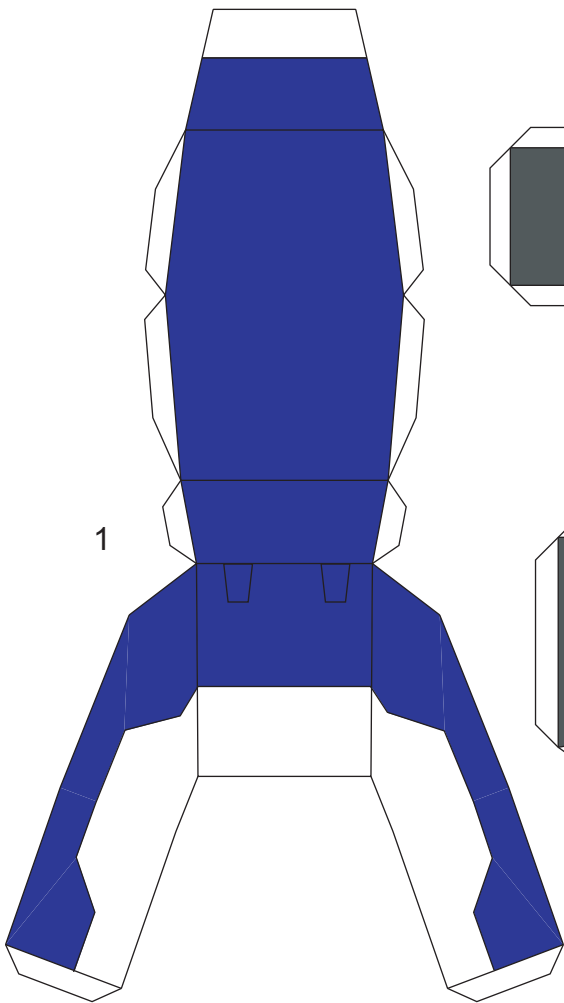

RX-78NT1 GUNDAM NT-1 #5

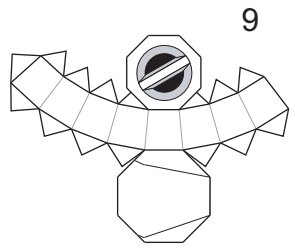
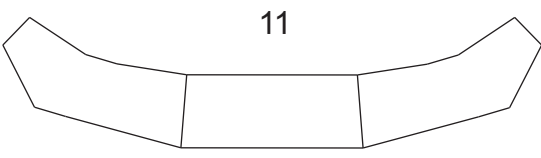
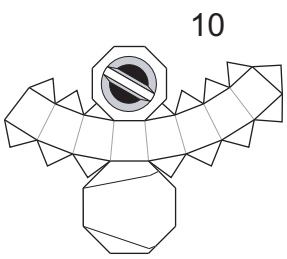
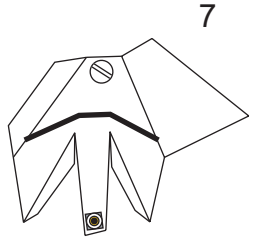
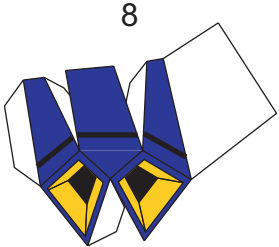
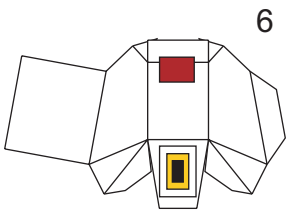
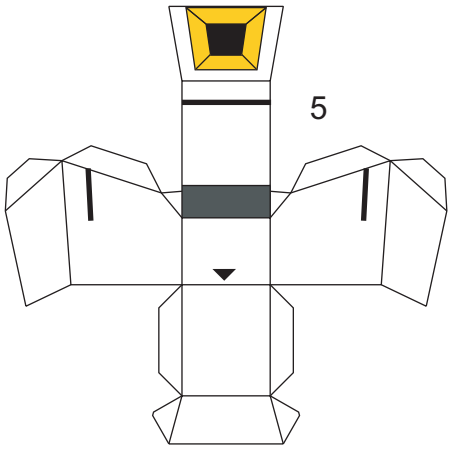
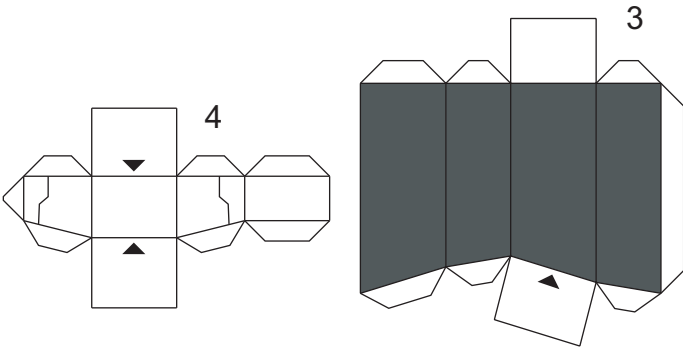
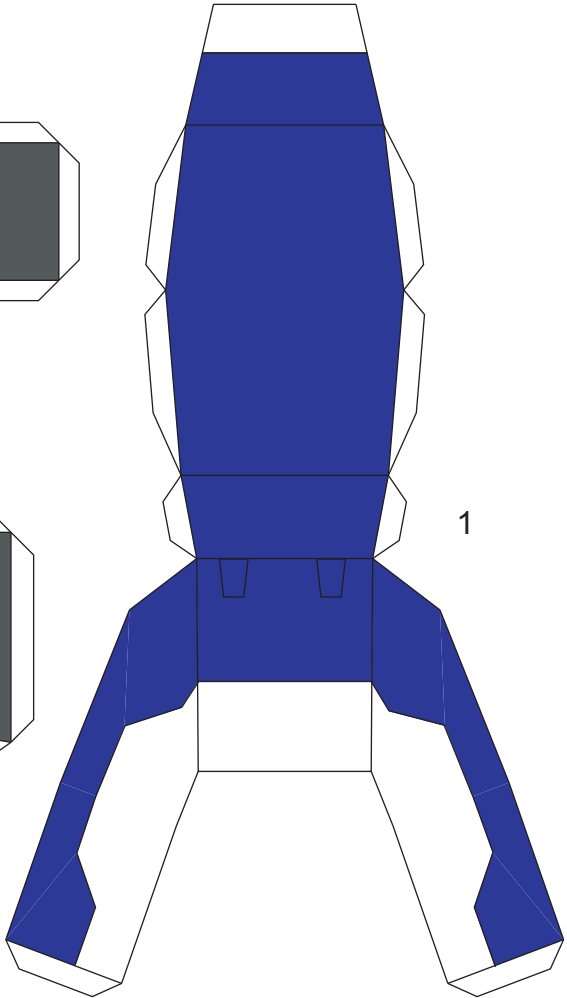
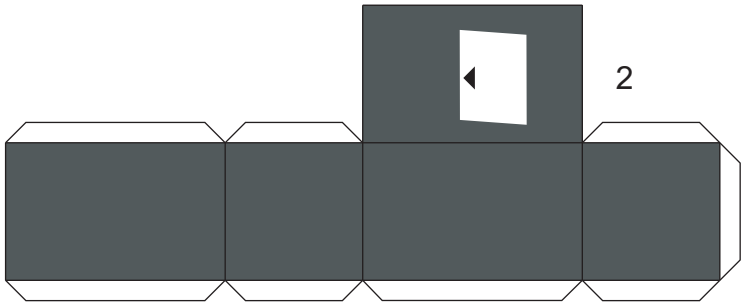

RX-78NT1 GUNDAM NT-1 #6

R L

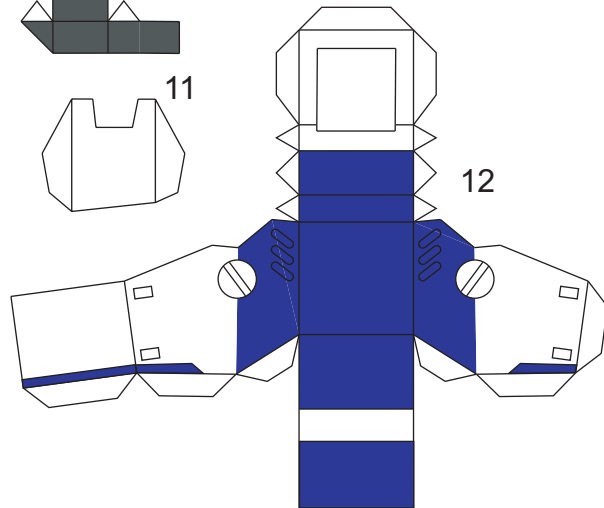
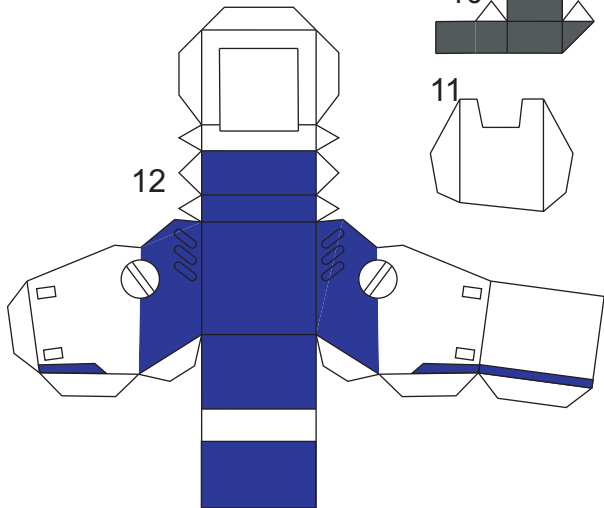
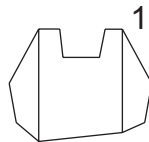
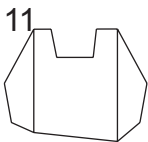
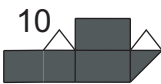
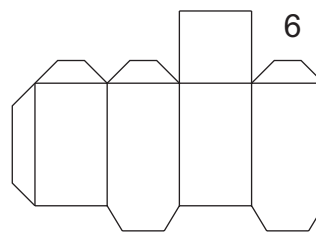
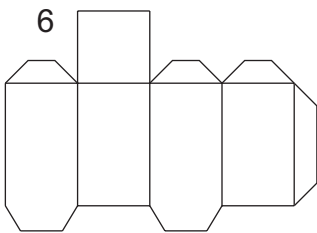
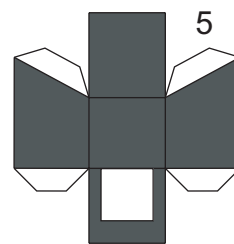
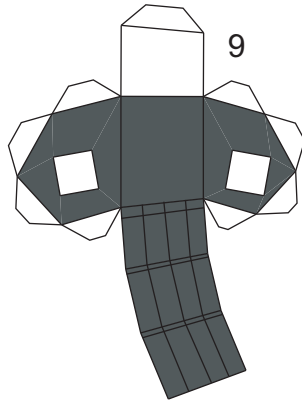
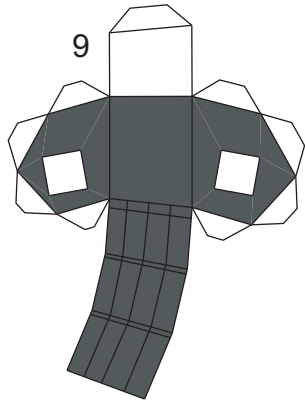
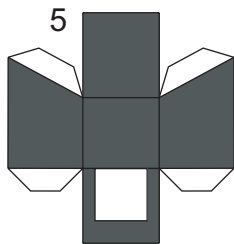
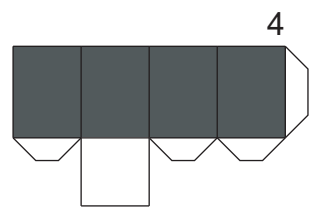
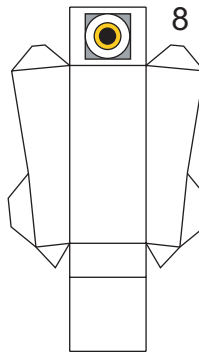
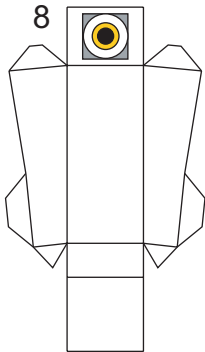
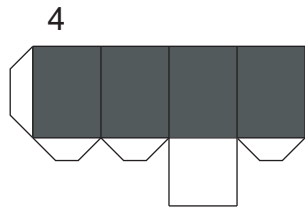
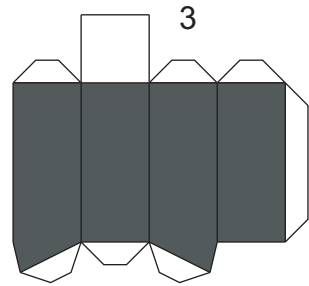
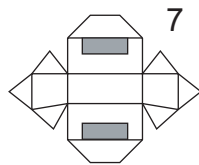
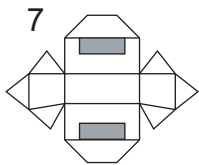
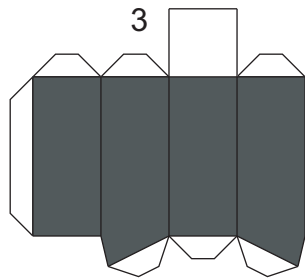
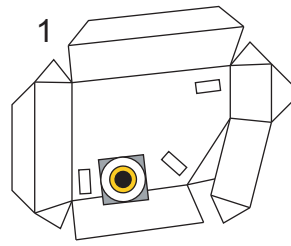
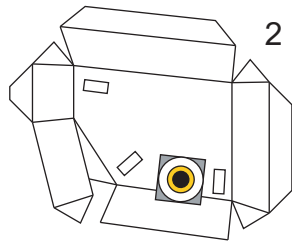
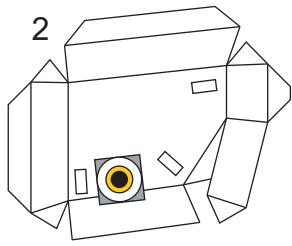
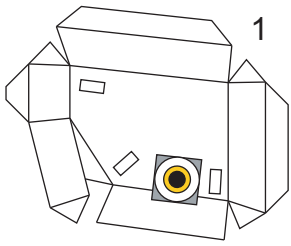

RX-78NT1 GUNDAM NT-1 #7

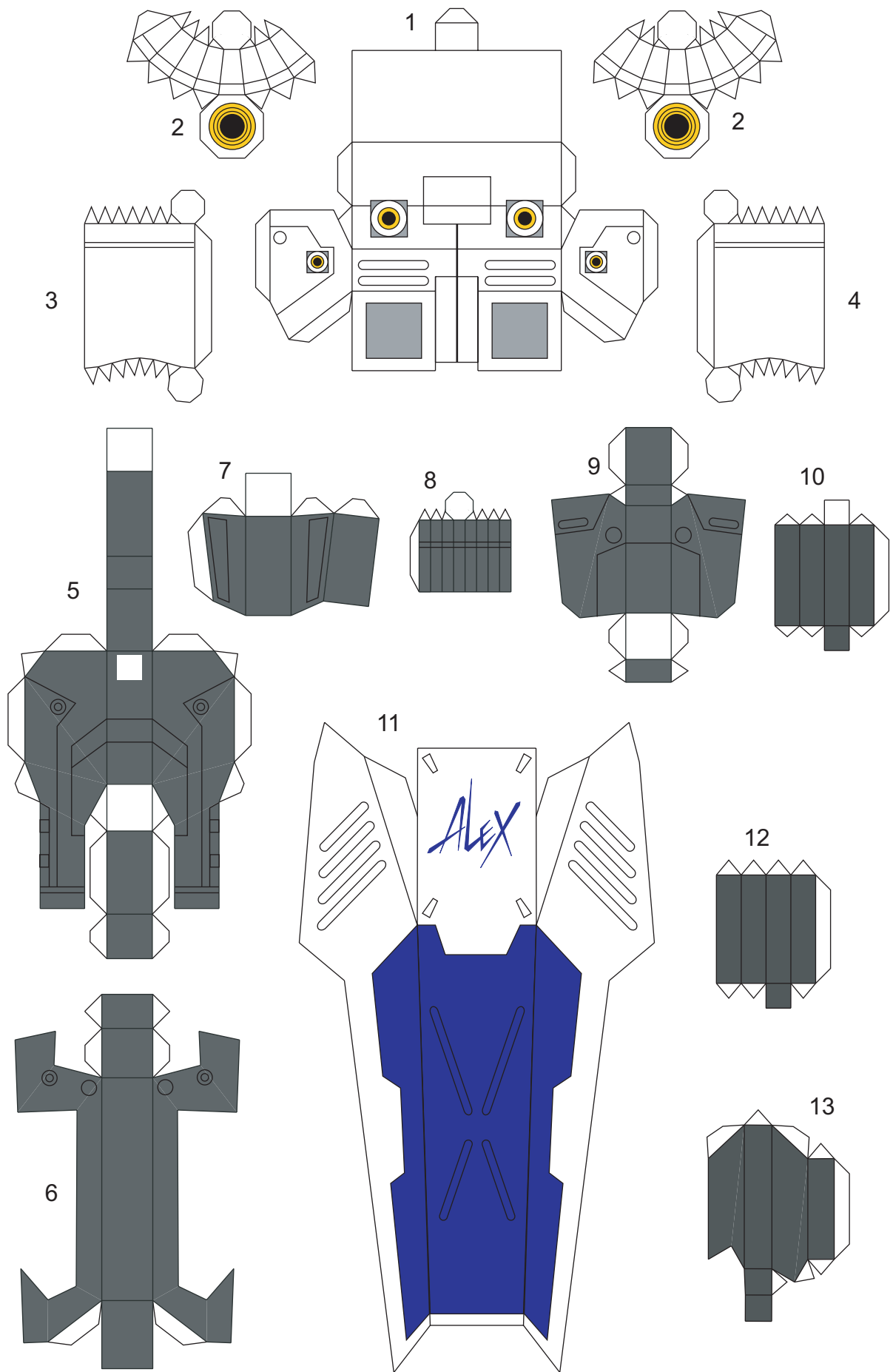

RX-78NT1 GUNDAM NT-1 #8

